

1000 SERIES MULTI-TRACK SLIDING DOORS

B 02

ELEVATIONS & PLAN DETAILS

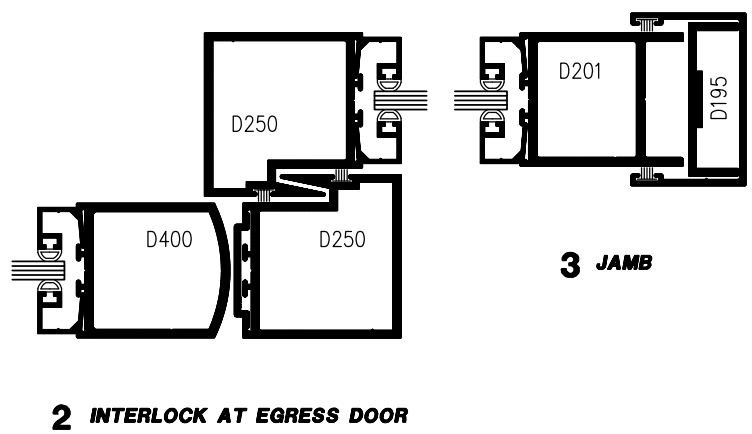
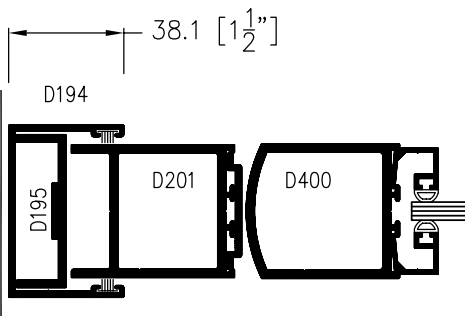
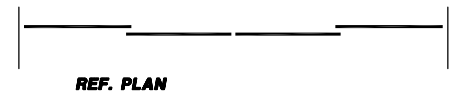
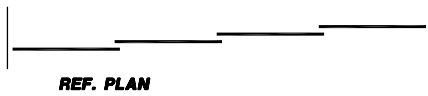
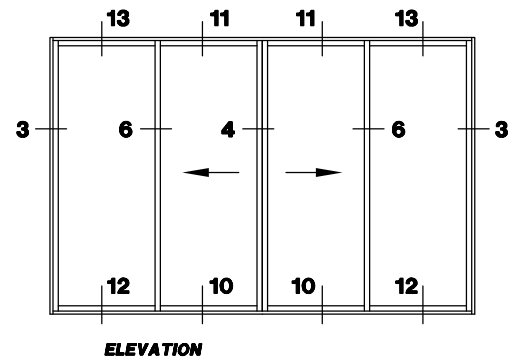
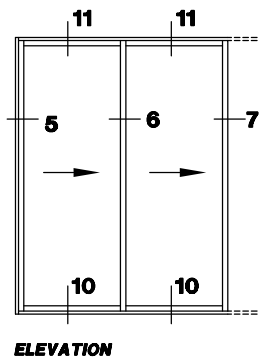
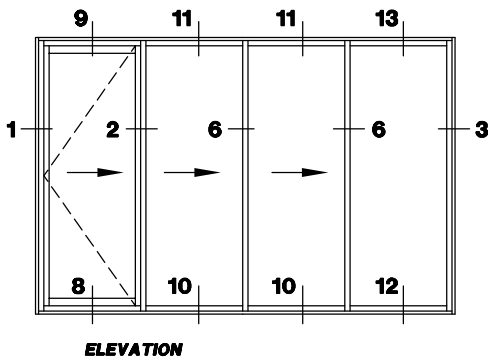

3 JAMB

