

# 350 SERIES

FIXED WINDOW SYSTEM

3 1/2" (88.9 mm)

# E 06

## DETAILS

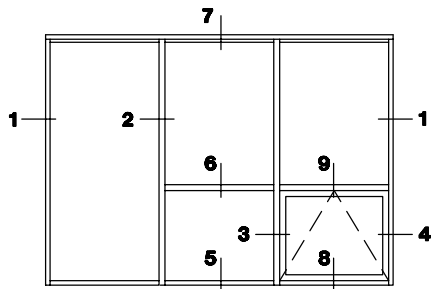

ELEVATION

2 OPTIONAL  
GLAZING

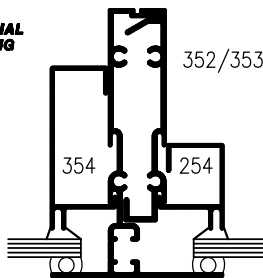

4 OPEN-IN  
VENT

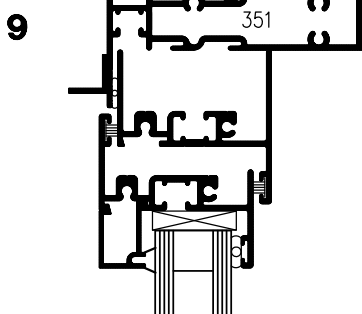
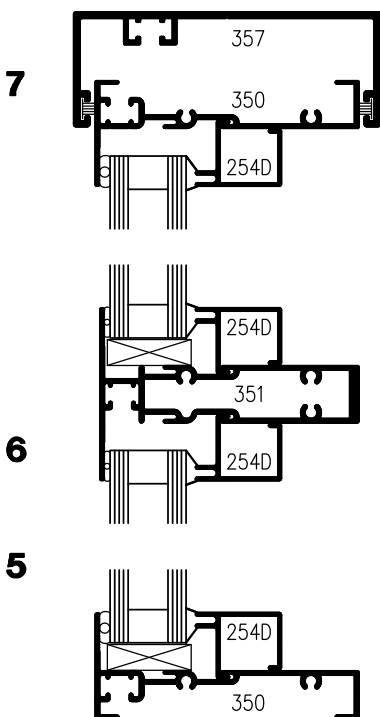
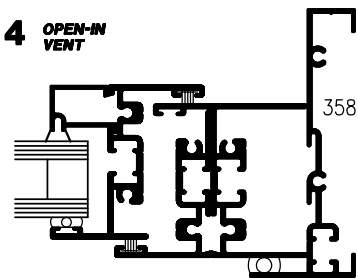

OPEN-OUT  
VENT  
200 SERIES

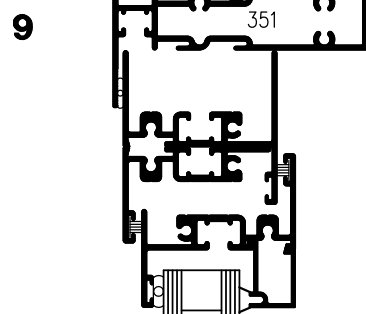

OPEN-IN  
VENT  
200 SERIES

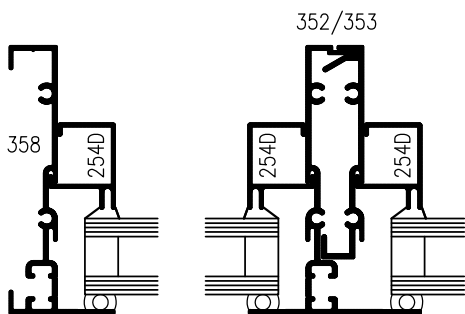
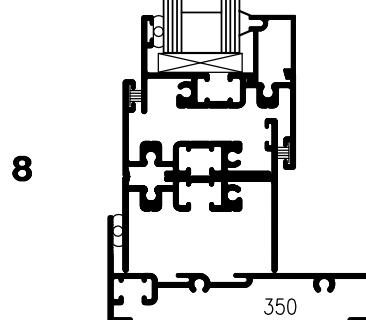
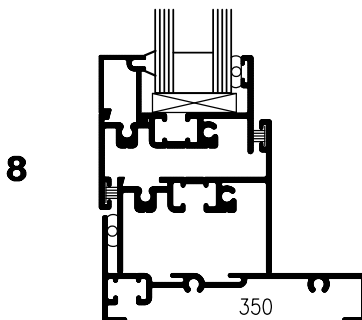

1

2

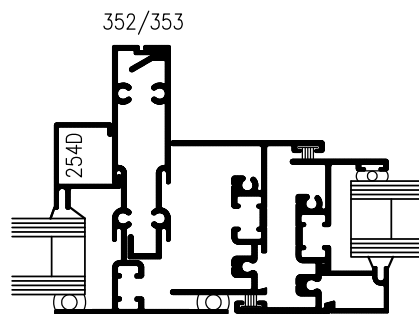

3

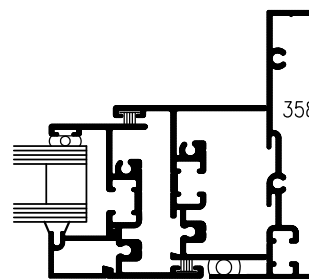

4