

2400 SERIES CURTAIN WALL & WINDOW SYSTEM NARROW - 2" (50.8 mm) - FRAME

D
06

TYPICAL DETAILS

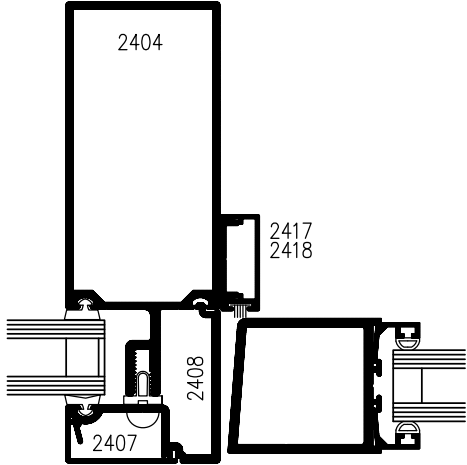

VISION

1

DOOR

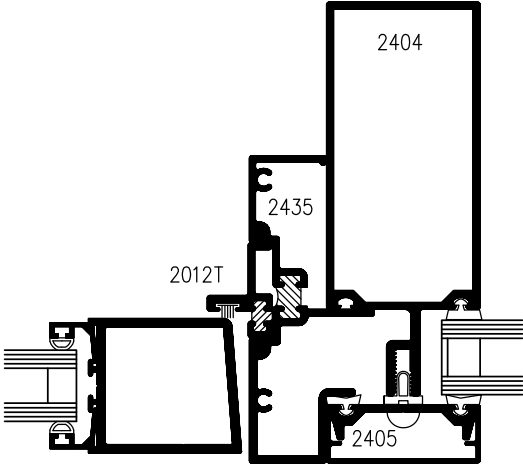

1a

VISION

2

VISION

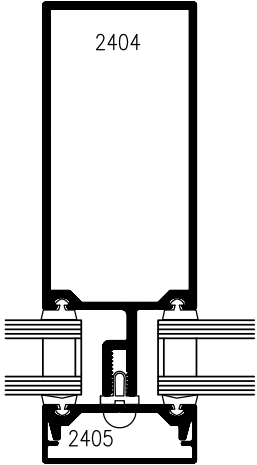

SPANDREL

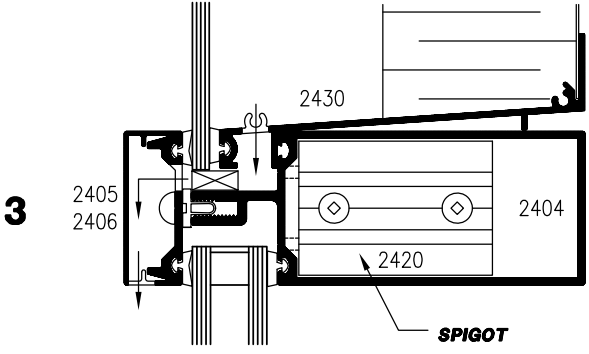

3

VISION

4

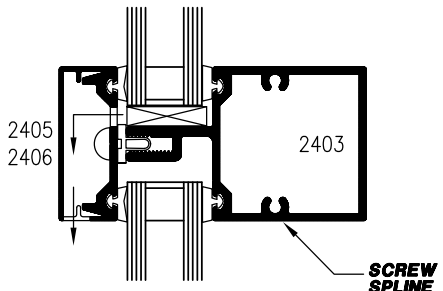

VISION

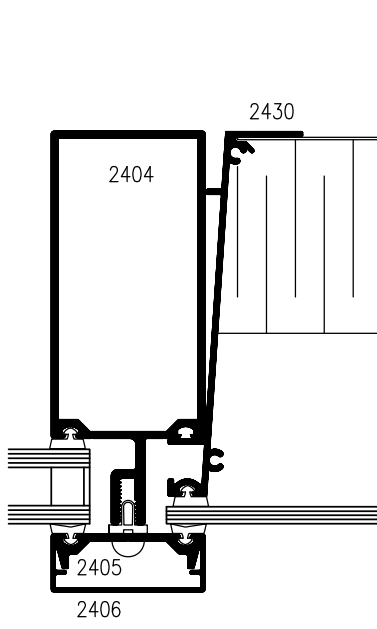

VISION

5

SPANDREL

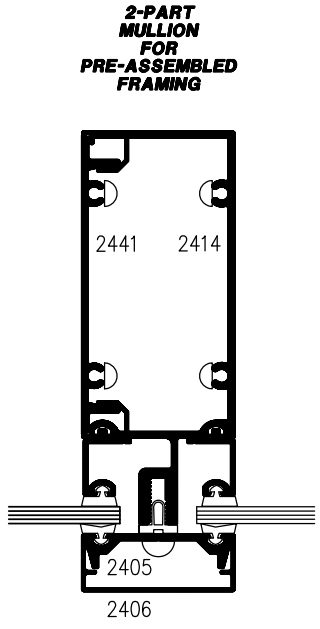

VISION

6

VISION

**2-PART
MULLION
FOR
PRE-ASSEMBLED
FRAMING**